

REQUEST FOR QUOTATION

Date: 29/01/2017

RFQ No. : RFQ/10CUU/ECHO/SANITATION/ERB/29012017

ACTED (Agency for Technical Cooperation and Development), in anticipation of upcoming projects that may require rapid deployment of emergency infrastructure, is seeking quotations for supply of the below products:

PRODUCT SPECIFICATIONS:

- | | |
|------------------------------------|--|
| 1. Description: | Construction, supply and installation of prefabricated latrines and showers. |
| 2. Quantities: | Quantities will be defined on demand, based on Purchase Orders submitted by ACTED. |
| 3. Product stage: | Finished products. |
| 4. Product class / category: | Supplies. |
| 5. INCOTERM (delivery conditions): | DDP as per map below (see annexes). |
| 6. Specifications: | As per detailed in the offer form and annexes. |

RESPONSIBILITIES OF THE CONTRACTOR:

- | | |
|------------------------|---|
| Validity of the offer: | 3 months. |
| Delivery leadtime: | Capacity for partial delivery within 48h after the signature of the contract. |

GENERAL CONDITIONS:

- The **closing date** of this RFQ is fixed on **05/02/2017 (February 5th, 2017) at 17:00 (Iraq time)** in ACTED office at the following address:
ACTED representative office in Erbil, IRAQ (6th street (Khabat street) on the right after Ankawa intersection, 1st street on the right, House #: 240/1/467 Hadiyab quarter, Ainkawa, Erbil, Iraq)

ACTED representative office in Dohuk: Golvin 67 St. Malta Islam Quarter - Dohuk 3rd Street from Malta Hill Traffic Light to **Down Town**

Or emailed to both: iraq.tender@acted.org and tender@acted.org
- Offers shall be submitted in English.
- Tenderers will fill, sign, stamp and return the Quotation Form.
- The offer should be provided using the below ACTED template.
- Tenderers will sign and return all pages of this document.
- Tenderers will provide evidence of experience undertaking similar work.
- The quotation will not directly result in the award of a contract.
- Prices are mandatory in US Dollar (USD).

SPECIFIC CONDITIONS:

- The contractor shall report to the WASH Programme Manager.
- The contractor should follow all instructions of any appointed ACTED supervising engineer.
- The contractor is to incur all duties, taxes, delivery and transport costs, including any fee or charge related to movements between Kurdistan Region of Iraq and Iraq.



ACTED
Agency for technical cooperation and development.

- Supply and installation can be requested over weekends and holidays given the emergency nature of these works.
- The contractor shall be available for the installation within 48h after the call-off.
- The contractor shall duly comply with the maximum lead time requirements of the offer.

Procurement Conditions

- All procurements should be done according to respective technical standards and specifications.
- All supplied items are subject to approval by supervising engineer in consultation with local authorities.
- Any change in the project or design shall not be carried on without previous approval from ACTED.
- Any additional costs not specified on the tender document will not be paid without previous approval from ACTED.



QUOTATION FORM

Details of Company

Company Name		Company Specialization	
Representative		Phone Number	
Registration Number		Email Address	
Country of Registration		Mailing Address	

PRE-FABRICATED EMERGENCY LATRINES AND SHOWERS

No.	Specification	Unit	Quantity (1)	Photo/Remarks	Unit Price USD (2)	Total Price USD (1) x (2)USD)
1. Construction and assembly of the substructure, pre-casting of slab						
1.1.	Pre-fabricated steel superstructures (size1x1.1x2m) for latrines/showers, the frame made from 40x40x1.5mm steel square sections. Door, walls and roof covered by steel corrugate white painted sheets and fixed by hex self-tapping screws (different sizes) with rubbers. Price to include slid lock, hinges, welding and all other works according to the attached drawings and photos (see annexes)	Pcs	20			

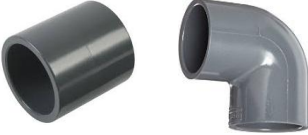
1.2.	Pre-casted reinforced concrete rings 90cm diameter, 100cm high and 7.5cm thickness having four drainage holes in the wall and putting properly in the pits, including sinking rings and gravel packing	Pcs	40			
1.3.	Pre-reinforced concrete slab (130x130x10cm) pre-casted for latrines floors, the price include a ceramic squatting pan installing and an aperture for disludging according to the drawing.	Pcs	10	Using 12mm steel bars every 15 cm both directions.		
1.4.	Ceramic or hard plastic squatting pan without water lock.	Pcs	10			
1.5.	Pre- reinforced concrete slab (130x130x10cm) pre-casted for showers floors, the price include installing of floor drain and pipe fitting to the open drainage.	Pcs	10	Using 6 mm 15x15 cm BRC steel mesh.		
1.6.	3" floor drain to be cast in concrete slab so that water drains away horizontally and PVC drain does not extend below the slab	Pcs	10			
1.7.	3" PVC socket and 90° bend depending on floor drain model (DIN standard PN10)	Pcs	10			
1.8.	3" PVC pipe (lengths of 3m) DIN standard PN10	Pcs	10	The pipes should be under ground up to the open channel.		

1.9.	Galvanized water steel tank (V= 21 L). Includes: steel tap, steel lid, and a valve	Pcs	10			
1.10.	Holding structure for galvanized water steel tank: 4 steel legs (H=0.5m, L=0.32m, W=0.32m), as per drawing attached.	Pcs	10	As per picture above and drawing in annexes		
2. Delivery and installation						
2.1.	Loading, transporting and unloading of 20 superstructures and 40 concrete rings to the identified sites through safe roads.	Trip	2 trip	Using crane machine for concrete rings loading and unloading.		
2.2.	Excavating a 120cm diameter circular pit with 4m depth and at least 100 or 110cm diameter for latrines.	No.	10	Using excavator driller machine.		
2.3.	Installing and tightening the superstructures above the (130x130x10cm) concrete base in 4 points by 6 mm anchored bolts according to the drawings.	Pcs	20	The concrete base should be level and stable.		
3. Maintenance tools						
3.1.	Toilet Jug	Pcs	10			

3.2.	Squeegee with long handle (for toilet/shower floor cleaning)	Pcs	10		-	
------	--	-----	----	---	---	--

BIDDER'S COMMENTS/REMARKS:

1. _____
2. _____

DELIVERY CONDITIONS GUARANTEED BY THE BIDDER:

1. _____
2. _____

Past experience and capability:

Please mention relevant contracts awarded to your company within the last two years, especially similar work with NGOs and any work in potentially insecure areas.

No	Project Description	Location	Partner Name	Duration	Project Cost (USD)	Are contact details of a reference available on request?
1						Yes / No
2						Yes / No
3						Yes / No
4						Yes / No
5						Yes / No

Please list your Company main assets relevant to the work above (machine, equipment, premises, warehouses, trucks & heavy machines). In particular, give detailed information about your fleet of kerosene tankers including sizes. ACTED may use this information to contact you again in future for other projects.

No	Description	Current location	Quantity
1			
2			
3			
4			
5			
6			
7			

DELIVERY TIME AND CAPACITY

..... days from contract signing until first delivery and installation of pcs superstructures (with associated toilet or shower floor) to specified locations.

COMPLEMENTARY INFORMATION

CAN YOU ACCESS ALL LOCATIONS WITHIN THE TWO AREAS DELIMITED BY BLUE LINES (SEE MAP IN ANNEXES)? **Yes / No**

HOW MANY DAYS DO YOU NEED BETWEEN NOTIFICATION OF REQUEST FOR LATRINE OR SHOWER IN ONE LOCATION AND COMPLETION OF THE WORK? _____

CAN YOU DELIVER AND INSTALL ONLY ONE LATRINE OR SHOWER IN A LOCATION? **YES / NO**
IF NO, WHAT IS THE MINIMUM BATCH SIZE OF LATRINES OR SHOWERS TO BE DELIVERED AND INSTALLED IN ONE LOCATION/CALL-OFF? _____

BIDDER'S COMMENTS/REMARKS:

Please continue on a separate blank sheet if necessary

TERMS AND CONDITIONS OF QUOTATION:

1. Validity of the offer: _____ (mandatory: minimum 3 months)
2. Terms of delivery: _____ (mandatory: DDP with installation included)
3. Terms of payment: _____

I undersigned _____, agree to provide ACTED, non-profit NGO, with items answering the above specifications, according to the stated conditions and responsibilities that I engage myself to follow.

Name of Company's Authorized Representative: _____

Authorized signature and stamp: _____

Date: _____

ANNEXES

You do not need to submit this and any following pages with your offer.

Annex 1: map of the possible locations (within the two areas delimited by blue lines);

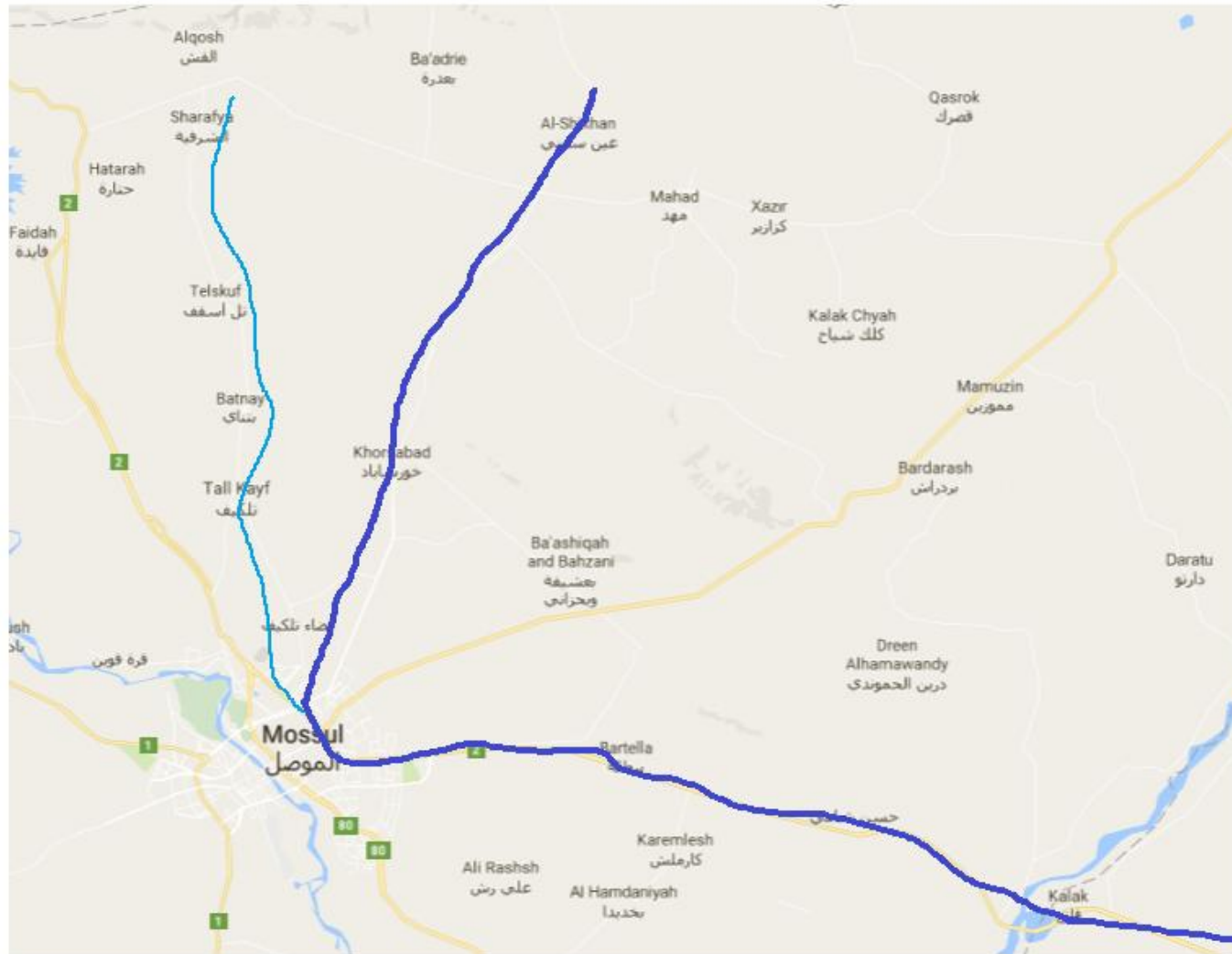

Annex 2: latrine substructure on pit rings

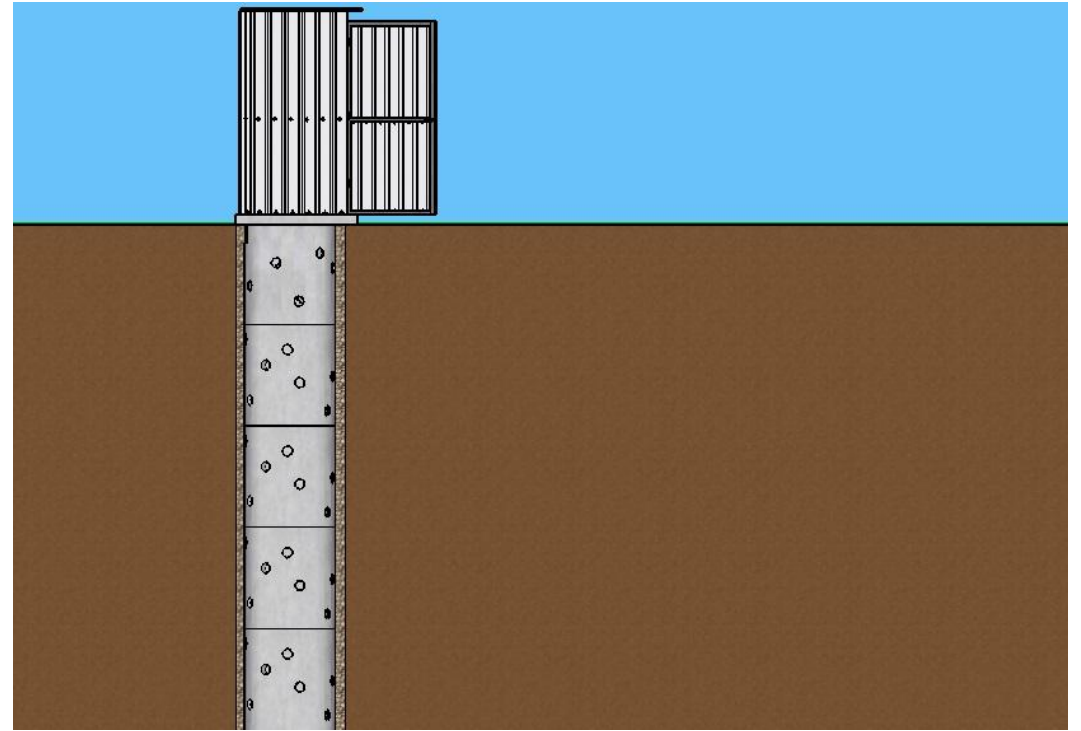
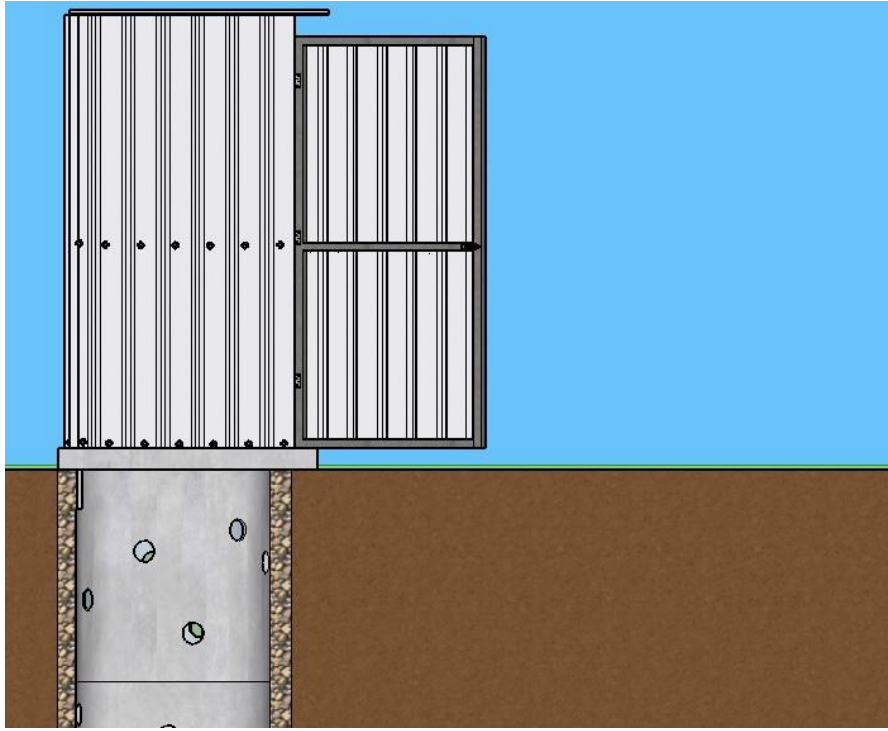

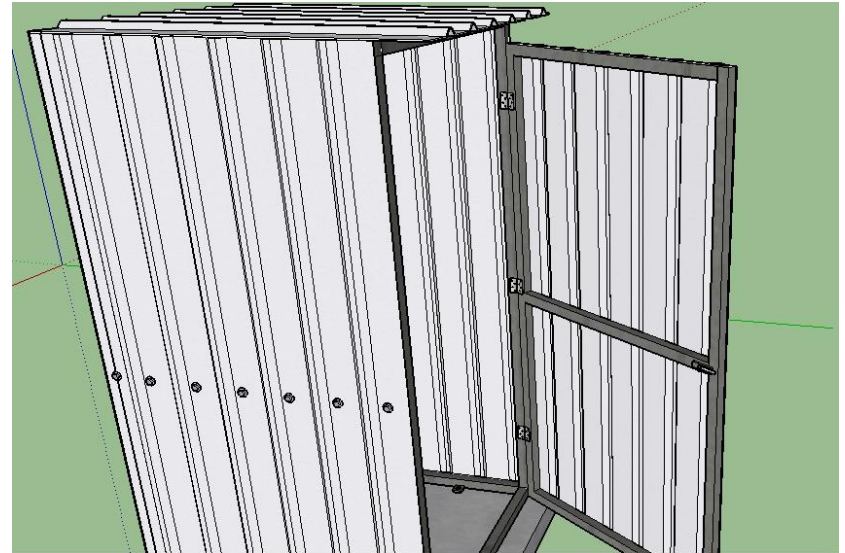
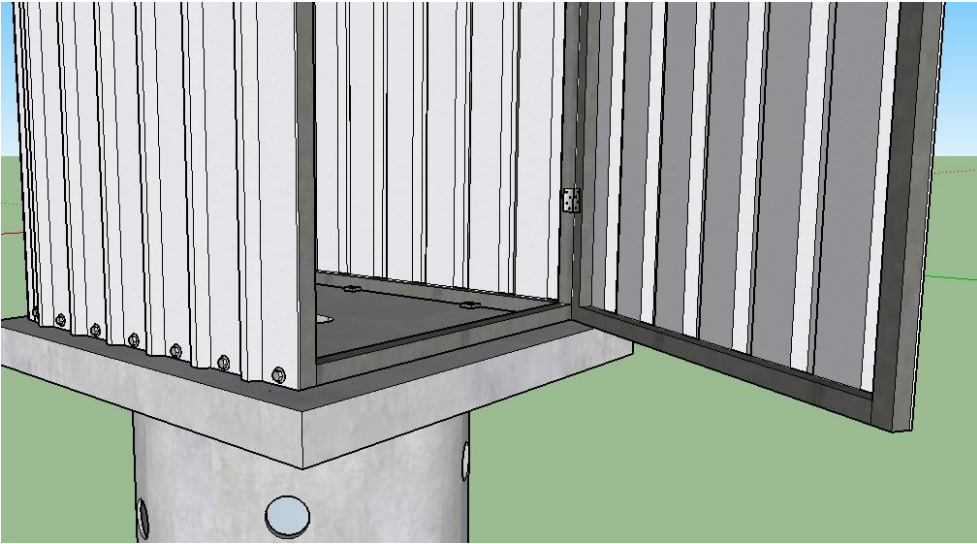

Annex 3: hand wash tank drawing

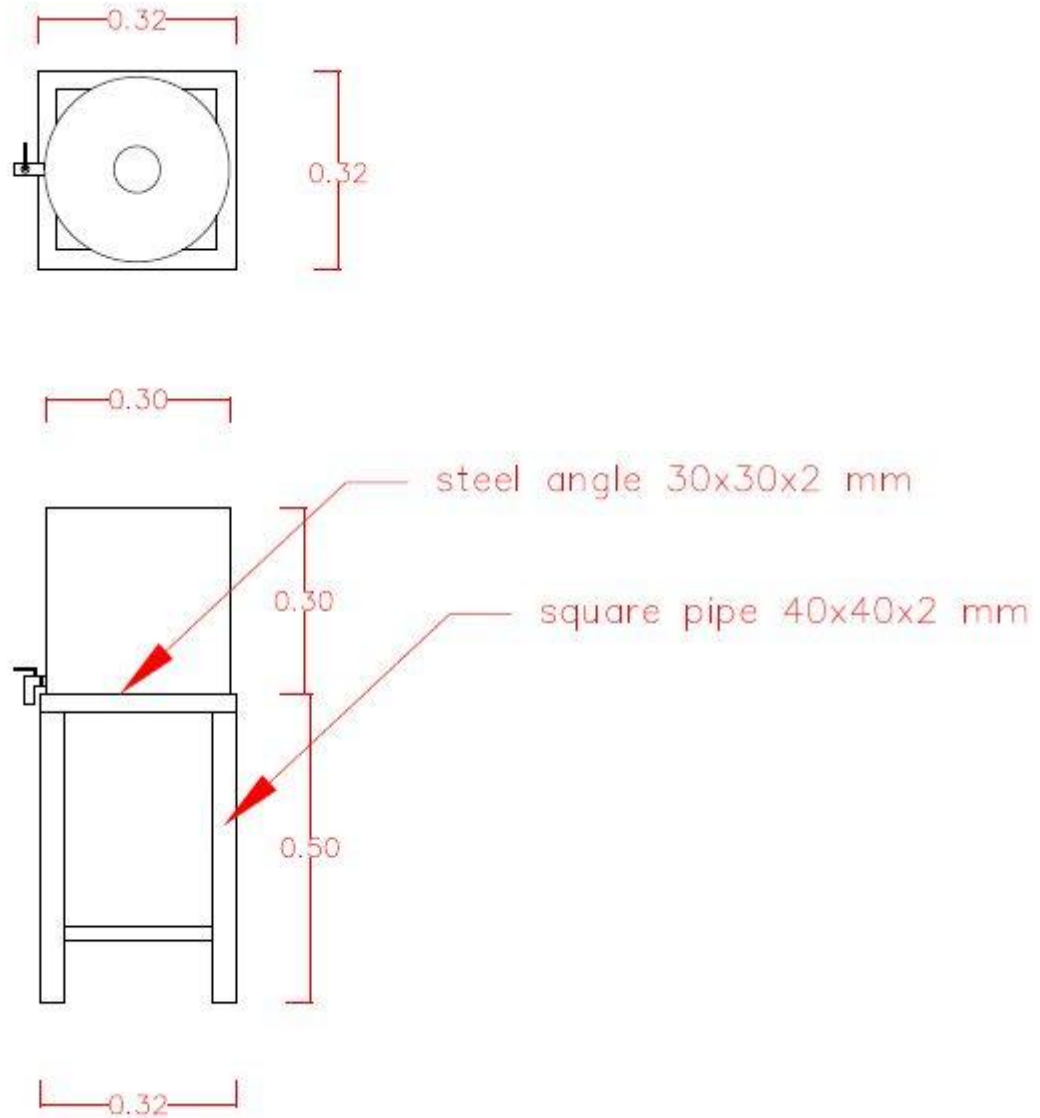

Annex 3: latrine drawings

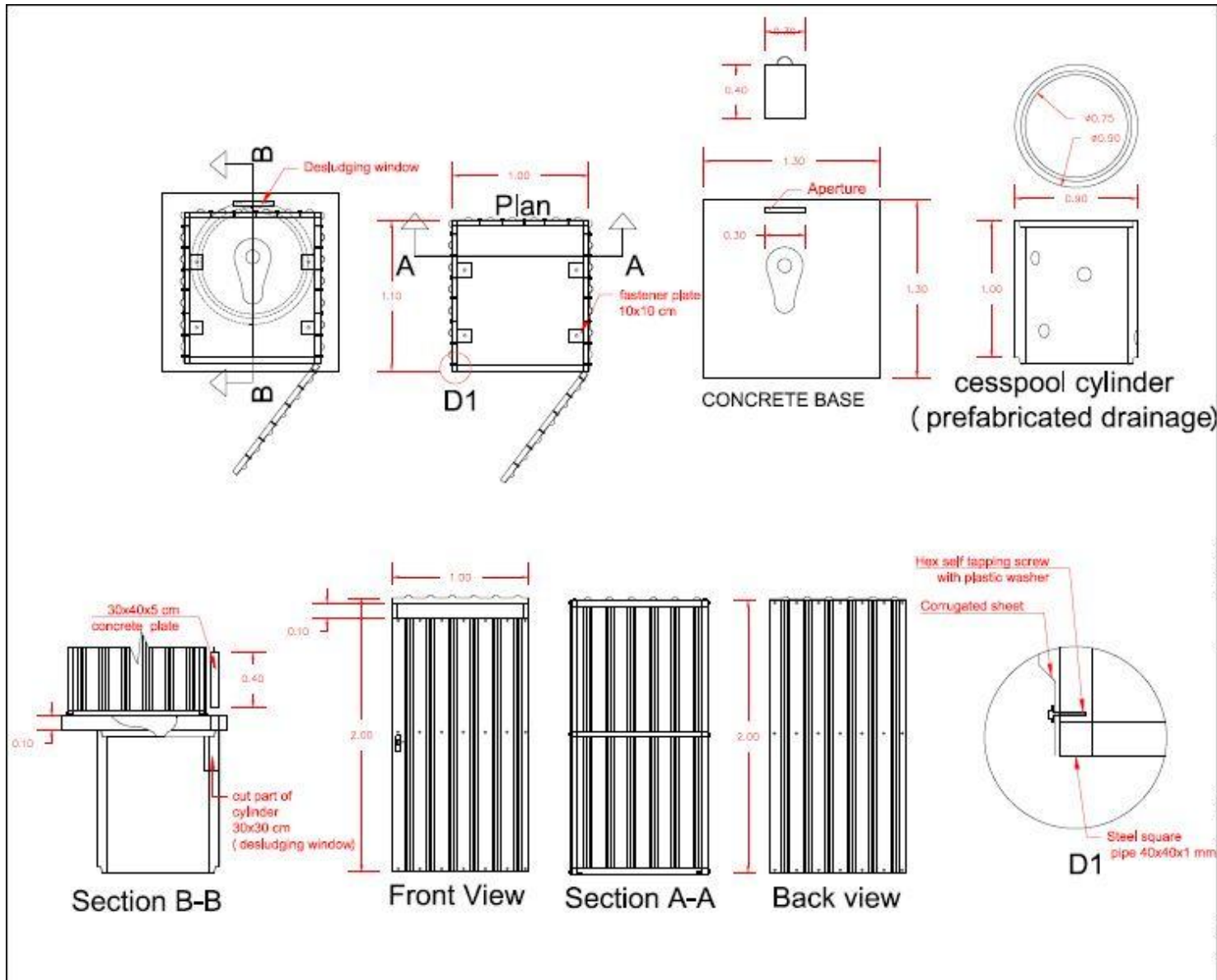

Annex 4: shower drawings

